iC60H circuit breakers (curve B, C, D) pages 2/2 to 2/4

iC60H and iC60H2 RCB0 10, 30 and 100 mA. pages 2/5 to 2/8

Vigi iC60 add-on residual current devices. pages 2/9 to 2/12

 A type pages 2/9 to 2/10

 SI type page 2/11

 AC type page 2/12

iID residual current circuit breakers pages 2/13 to 2/16

 A type page 2/13

 SI type page 2/14

 AC, A, SI type pages 2/15 to 2/16

Electrical auxiliaries for iC60, iID, iDPN Vigi, RCA and ARA. pages 2/17 to 2/23

***Accessories for iC60, iID, iDPN Vigi, Reflex iC60, RCA
ARA and iSW. pages 2/24 to 2/29***





BS/EN 60947-2 BS/EN 60898-1

- iC60H circuit breakers are multi-standard circuit breakers which combine the following functions:
 - circuit protection against short-circuit currents,
 - circuit protection against overload currents,
 - suitable for industrial isolation according to IEC/EN 60947-2, standard.
 - fault tripping indication by a red mechanical indicator in circuit breaker front face.

Alternating current (AC) 50/60 Hz

Breaking capacity (Icu) according to IEC/EN 60947-2						Service breaking capacity (Ics)
Ph/Ph (2P, 3P, 4P)	Voltage (Ue)					
	12 to 133 V	220 to 240 V	380 to 415 V	440 V		100 % of Icu
Ph/N (1P)	12 to 60 V	100 to 133 V	220 to 240 V	-		
Rating (In)	1 to 4 A	70 kA	70 kA	70 kA	50 kA	100 % of Icu
	6 to 40 A	42 kA	30 kA	15 kA	10 kA	50 % of Icu
	50/63 A	42 kA	-	15 kA	10 kA	50 % of Icu

Breaking capacity (Icn) according to IEC/EN 60898-1



Breaking capacity (Icn) according to IEC/EN 60898-1	
Ph/Ph	Voltage (Ue)
Ph/Ph	400 V
Ph/N	230 V
Rating (In)	1 to 63 A 10000 A

Direct current (DC)

Breaking capacity (Icu) according to IEC/EN 60947-2						Service breaking capacity (Ics)
Between +/-	Voltage (Ue)					
	12 to 48 V	72 V	100 to 133 V		220 to 250 V	100 % of Icu
Number of poles	1P		2P (in series)	3P (in series)	4P (in series)	
Rating (In)	1 to 63 A	20 kA	10 kA	10 kA	20 kA	10 kA

Catalogue numbers

iC60H circuit breaker

Type	1P			2P		
						
Current rating (In)	Curve			Curve		
	B	C	D	B	C	D
1 A	A9F53101	A9F54101	A9F55101	A9F53201	A9F54201	A9F55201
2 A	A9F53102	A9F54102	A9F55102	A9F53202	A9F54202	A9F55202
3 A	A9F53103	-	-	-	-	-
4 A	A9F53104	A9F54104	A9F55104	A9F53204	A9F54204	A9F55204
6 A	A9F53106	A9F54106	A9F55106	A9F53206	A9F54206	A9F55206
10 A	A9F53110	A9F54110	A9F55110	A9F53210	A9F54210	A9F55210
16 A	A9F53116	A9F54116	A9F55116	A9F53216	A9F54216	A9F55216
20 A	A9F53120	A9F54120	A9F55120	A9F53220	A9F54220	A9F55220
25 A	A9F53125	A9F54125	A9F55125	A9F53225	A9F54225	A9F55225
32 A	A9F53132	A9F54132	A9F55132	A9F53232	A9F54232	A9F55232
40 A	A9F53140	A9F54140	A9F55140	A9F53240	A9F54240	A9F55240
50 A	A9F53150	A9F54150	A9F55150	A9F53250	A9F54250	A9F55250
63 A	A9F53163	A9F54163	A9F55163	A9F53263	A9F54263	A9F55263
Width in 9-mm modules	2			4		

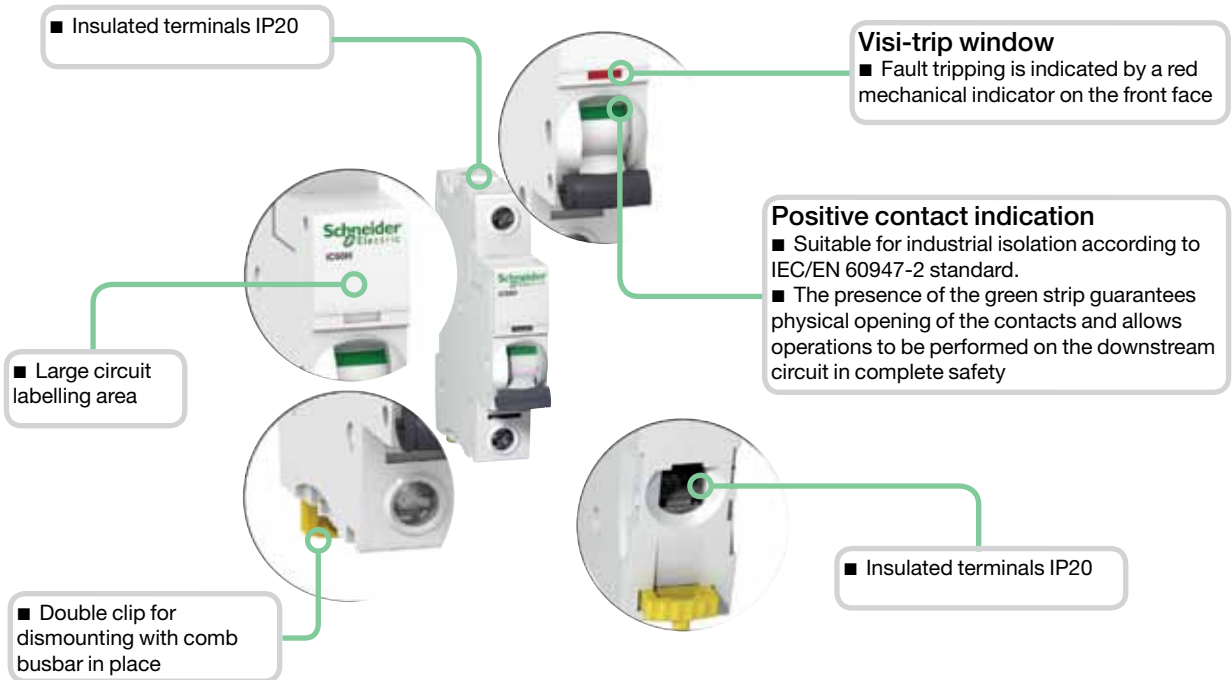

- Increased product service life thanks to:
 - overvoltage resistance by high level of industrial performances conception (pollution degree, rated impulse withstand voltage and insulation voltage),
 - high performance limitation (see limitation curves),
 - fast closing independent of the speed of actuation of the toggle.
- Remote indication, open/closed/tripped, by optional auxiliary contacts.
- Top or bottom electrical feeding.

E-45095	3P			E-45097	4P		
	Curve B	Curve C	Curve D		Curve B	Curve C	Curve D
	A9F53301	A9F54301	A9F55301	A9F53401	A9F54401	A9F55401	
	A9F53302	A9F54302	A9F55302	A9F53402	A9F54402	A9F55402	
	-	-	-	-	-	-	
	A9F53304	A9F54304	A9F55304	A9F53404	A9F54404	A9F55404	
	A9F53306	A9F54306	A9F55306	A9F53406	A9F54406	A9F55406	
	A9F53310	A9F54310	A9F55310	A9F53410	A9F54410	A9F55410	
	A9F53316	A9F54316	A9F55316	A9F53416	A9F54416	A9F55416	
	A9F53320	A9F54320	A9F55320	A9F53420	A9F54420	A9F55420	
	A9F53325	A9F54325	A9F55325	A9F53425	A9F54425	A9F55425	
	A9F53332	A9F54332	A9F55332	A9F53432	A9F54432	A9F55432	
	A9F53340	A9F54340	A9F55340	A9F53440	A9F54440	A9F55440	
	A9F53350	A9F54350	A9F55350	A9F53450	A9F54450	A9F55450	
	A9F53363	A9F54363	A9F55363	A9F53463	A9F54463	A9F55463	
6				8			

2

Connection

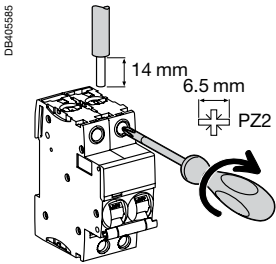

Rating	Tightening torque	Without accessory		With accessories		
		Rigid	Flexible or ferrule	50 mm ² Al terminal	Screw-on connection for ring terminal	Multi-cables terminal
1 to 25 A	2 N.m	DB1229345	DB1229346	DB1229345	DB118789	DB118787
32 to 63 A	3.5 N.m			50 mm ²		

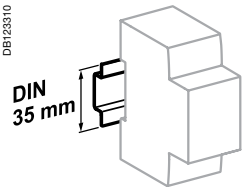

Clip on DIN rail 35 mm.

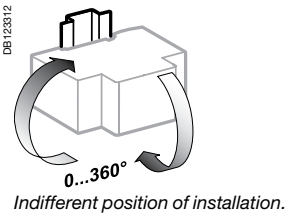

Indifferent position of installation.

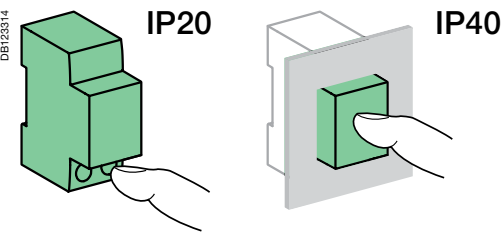

Technical data

Main characteristics	
According to IEC/EN 60947-2	
Insulation voltage (Ui)	500 V AC
Pollution degree	3
Rated impulse withstand voltage (Uimp)	6 kV
Thermal tripping	Reference temperature 50°C
Magnetic tripping	B curve 4 In ± 20 % C curve 8 In ± 20 % D curve 12 In ± 20 %
Utilization category	A
According to IEC/EN 60898-1	
Limitation class	3
Rated making and breaking capacity of an individual pole (Icn1)	Icn1 = Icn
Additional characteristics	
Breaking capacity under 1 pole with IT 380-415 V isolated neutral system (case of double fault)	40 A 4 kA 50/63 A 3 kA
Degree of protection (IEC 60529)	Device only IP20 Device in modular enclosure IP40 Insulation classe II
Endurance (O-C)	Electrical 10,000 cycles Mechanical 20,000 cycles
Overvoltage category (IEC 60364)	IV
Operating temperature	-35°C to +70°C
Storage temperature	-40°C to +85°C
Tropicalization (IEC 60068-1)	Treatment 2 (relative humidity 95 % to 55°C)

Dimensions (mm)

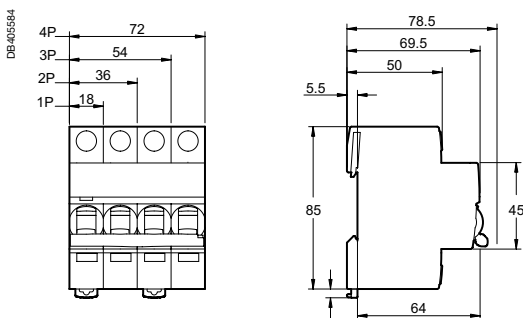

Weight (g)

Circuit-breaker	
Type	iC60H
1P	125
2P	250
3P	375
4P	500



IEC 61009-1,
IEC 61009-2-2,
BS EN 61009-1

- The single-phase iC60H RCBO's self-contained residual current device carries out complete protection of final circuits:
 - protection against short-circuits and cable overloads
 - protection of persons against electric shock by direct contact (10, 30 mA sensitivities),
 - protection of equipment against fires set by leakage currents (100 mA sensitivity).
- The neutral is not interrupted when the device is tripped. Hence iC60H RCBO can be used on most circuits, except for the ones operating under TT or IT earthing systems when the neutral needs to be isolated.

2

Alternating current (AC) 50/60 Hz

Breaking capacity (I_{cn}) according to IEC 61009-1

Ph/N	Voltage (U _e)	
	110 V	240 V
Rating (I _n) 6 to 45 A	10000 A	10000 A

Accessory

Padlocking device

- A9A27049 for pack of 10. Used to lock the toggle in the "open" or "closed" position by 4 mm diameter padlock (not supplied).

Catalogue numbers

iC60H RCBO 10000						
1P+N			A			Width in 9-mm modules
B curve	Voltage rating (V)	Sensitivity (I _{Δn})	10 mA	30 mA	100 mA	
<small>DB405038</small> 	240	Rating (I _n) 6 A	-	A9D31806	-	2
		10 A	-	A9D31810	-	
		16 A	-	A9D31816	-	
		20 A	-	A9D31820	-	
		25 A	-	A9D31825	-	
		32 A	-	A9D31832	-	
		40 A	-	A9D31840	-	
<small>DB405038</small> 	110	Rating (I _n) 10 A	-	A9D19810	-	2
		16 A	-	A9D19816	-	
		20 A	-	A9D19820	-	
		25 A	-	A9D19825	-	
		32 A	-	A9D19832	-	
	240	Rating (I _n) 6 A	A9D10806	A9D11806	A9D12806	
		10 A	A9D10810	A9D11810	A9D12810	
		16 A	A9D10816	A9D11816	A9D12816	
		20 A	A9D10820	A9D11820	A9D12820	
		25 A	A9D10825	A9D11825	A9D12825	
		32 A	A9D10832	A9D11832	A9D12832	
		40 A	A9D10840	A9D11840	A9D12840	
		45 A	A9D10845	A9D11845	A9D12845	
		Operating frequency			50...60 Hz	

Accessory	
Type	
Padlocking device (bag of 10 pieces)	A9A27049



IEC 61009-1,
IEC 61009-2-2,
AS/NZS 61009.1

- The 2-pole iC60H2 RCBO's self-contained residual current device carries out
 - complete protection of final circuits:
 - protection against short-circuits and cable overloads,
 - protection of persons against electric shock by direct contact (30 mA sensitivities),
 - protection of equipment against fires set by leakage currents (300 mA sensitivity).
 - iC60H2 RCBO switches neutral, together with phase. It is therefore suitable for all circuits, whatever the earthing system (except for TN-C).

Alternating current (AC) 50/60 Hz

Breaking capacity (Icn) according to IEC 61009-1

Ph/N, Ph/Ph	Voltage (Ue)	
	110 V	240 V
Rating (In)	10 to 32 A	10000 A

Accessory

Padlocking device

- A9A27049 for pack of 10. Used to lock the toggle in the "open" or "closed" position by 4 mm diameter padlock (not supplied).

Catalogue numbers

iC60H2 RCBO 10000

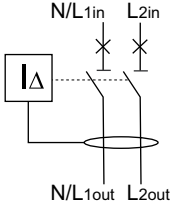
2P		A 	Width in 9-mm modules	
	110	Rating (In)	4	
		10 A		A9D19210
		16 A		A9D19216
		20 A		A9D19220
		25 A		A9D19225
		32 A		A9D19232
	240	Rating (In)		
		10 A		A9D11210
		16 A		A9D11216
		20 A		A9D11220
		25 A		A9D11225
		32 A		A9D11232
Operating frequency		50...60 Hz		

Technical data

Main characteristics		iC60H RCBO	iC60H2 RCBO
Insulation voltage (Ui)		400 V AC	
Rated impulse withstand voltage (Uimp)		4 kV	
Rated residual operating current (IΔn)		10, 30, 100 mA	30 mA
Thermal tripping	Reference temperature	50°C	
Limitation class		3	
Surge current withstand (8/20 μs) without tripping		250 A	
Rated nominal breaking capacity (Icn)		10,000 A	10,000 A
Phase/earth rated residual breaking and making capacity (IΔm)		7,500 A	7,500 A
Additional characteristics			
Degree of protection	Device only	IP20	
	Device in modular enclosure	IP40	
Endurance (O-C)	Electrical	5,000 cycles	
	Mechanical	20,000 cycles	
Operating temperature		-15°C to +60°C	
Storage temperature		-40°C to +85°C	
Tropicalization		Treatment 2 (relative humidity: 95 % at 55°C)	

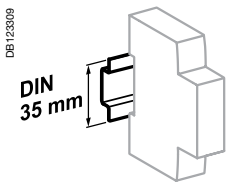

Clip on DIN rail 35 mm.

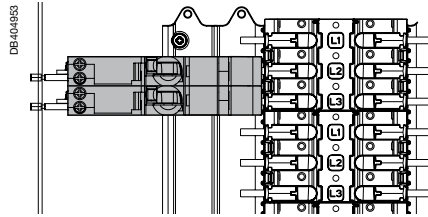

Installation on Isobar.

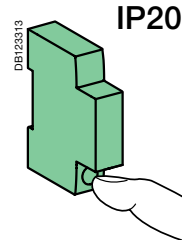

IP20

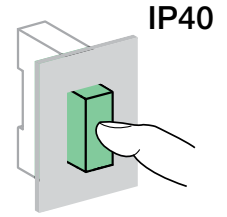

IP40

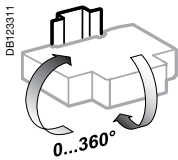

Indifferent position of installation.

Weight (g)

iC60 RCBO	
iC60H RCBO	205
iC60H2 RCBO	332

Dimensions (mm)

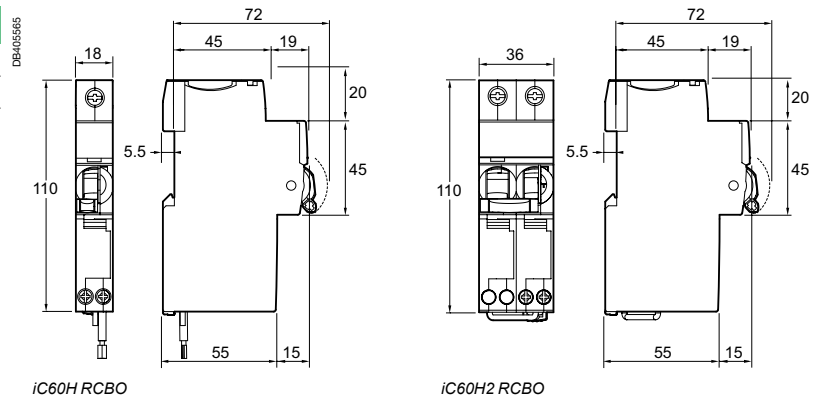

Protection

Earth leakage protection

iC60H RCBO

10, 30 and 100mA (cont.)

2

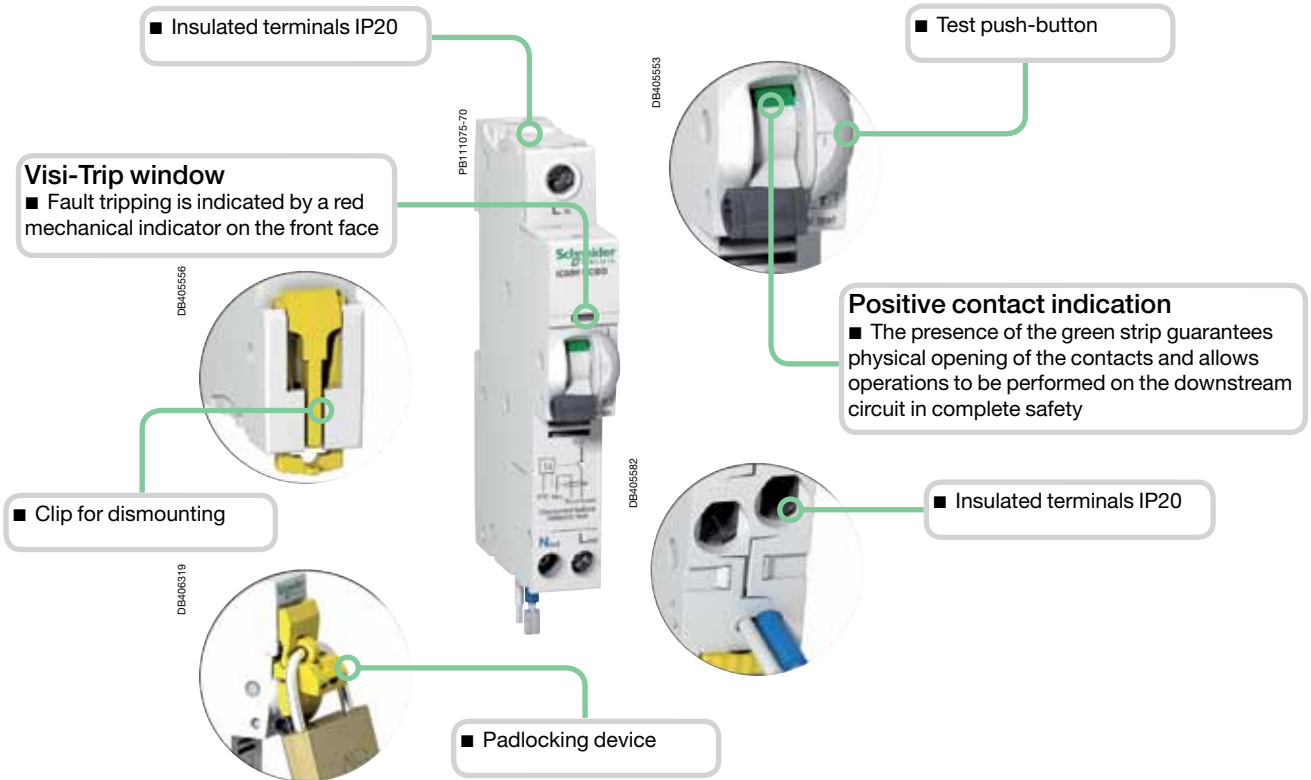

- Increased product service life thanks to fast closing independent of the speed of actuation of the toggle.
- Remote indication, open/closed/tripped, by optional auxiliary contacts.

Connection

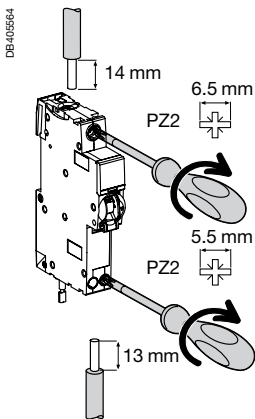

Type	Rating	Tightening torque	Copper cables	
			Rigid	Flexible
N in and L in	6 to 45 A	3.5 N.m	DB122345	DB122346
L out and N out			2 N.m	1 to 16 mm ²

Protection Earth leakage protection

Vigi iC60 add-on residual current devices (type A)

IEC/EN 61009-1



- Combined with iC60 circuit breaker, the Vigi iC60 provide:
 - protection of persons against electric shock by direct contact (30 mA),
 - protection of persons against electric shock by indirect contact (≥ 100 mA),
 - protection of installations against the risk of fire (300 mA),
 - use with 1/2 pole or 3/4 pole iC60H.

2

Catalogue numbers

Vigi iC60 add-on residual current devices						
Type	A				Width in 9 mm modules	
Product	Vigi iC60					
Auxiliaries	Without auxiliaries					
	Sensitivity	30 mA	100 mA	300 mA		
DB122462 	Rating	25 A			3	
		63 A	A9V02663 A9V01663*	A9V03663	A9V06663	4
DB122464 	Rating	63 A	A9V02763	-	A9V06763	6
Voltage rating (Ue)		230 - 240 V, 400 - 415 V Except * 110 V				
Operating frequency		50/60 Hz				



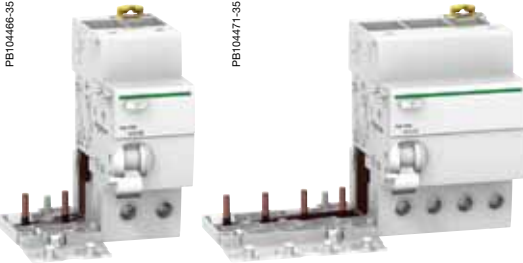

IEC/EN 61009-1



- Combined with iC60 circuit breaker, the Vigi iC60 provide:
 - protection of persons against electric shock by direct contact (30 mA),
 - protection of persons against electric shock by indirect contact (≥ 100 mA),
 - protection of installations against the risk of fire (300 mA or 500 mA)),
 - use with 2 pole or 4 pole iC60H only.

2

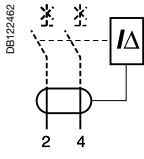
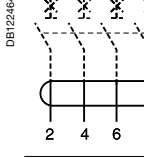
Catalogue numbers

Vigi iC60 add-on residual current devices									
Type	A 							Width in 9 mm modules	
Product	Vigi iC60								
Auxiliaries	Without auxiliaries								
	Sensitivity	30 mA	100 mA	300 mA	500 mA	300 mA 	1000 mA 		
2P 	Rating	25 A	A9V51225	A9V22225	A9V54225	A9V26225	-	3	
		63 A	A9V51263	A9V22263	A9V54263	A9V26263	A9V25263	A9V29263	4
4P 	Rating	25 A	A9V51425	A9V22425	A9V54425	A9V26425	-	6	
		63 A	A9V51463	A9V22463	A9V54463	A9V26463	A9V25463	A9V29463 	7
Voltage rating (Ue)		230 - 240 V, 400 - 415 V							
Operating frequency		50/60 Hz							

Protection Earth leakage protection

Vigi iC60 add-on residual current devices (SI type)

IEC/EN 61009-1

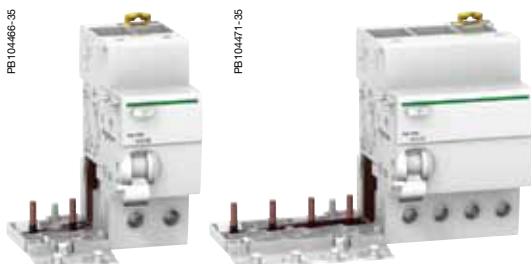

- Combined with iC60 circuit breaker, the Vigi iC60 provide:
 - protection of persons against electric shock by direct contact (≤ 30 mA),
 - protection of persons against electric shock by indirect contact (≥ 300 mA),
 - protection of installations against the risk of fire (300 mA),
 - use with 2 pole or 4 pole iC60H only.

The **SI** type provides increased immunity from electrical interference and polluted or corrosive environments.

2

Catalogue numbers

Vigi iC60 add-on residual current devices							
Type	SI					Width in 9 mm modules	
Product	Vigi iC60						
Auxiliaries	Without auxiliaries						
2P	Sensitivity	10 mA	30 mA	300 mA	1000 mA		
	Rating	25 A	A9V30225	A9V61225	-	3	
		40 A	-	A9V61240	-	4	
		63 A	-	A9V61263	A9V65263	A9V39263	4
	Rating	25 A	-	A9V61425	-	6	
		40 A	-	A9V61440	-	7	
		63 A	-	A9V61463	A9V65463	A9V39463	7
Voltage rating (Ue)		230 - 240 V, 400 - 415 V					
Operating frequency		50/60 Hz					

Protection Earth leakage protection

Vigi iC60 add-on residual current devices (AC type)

2

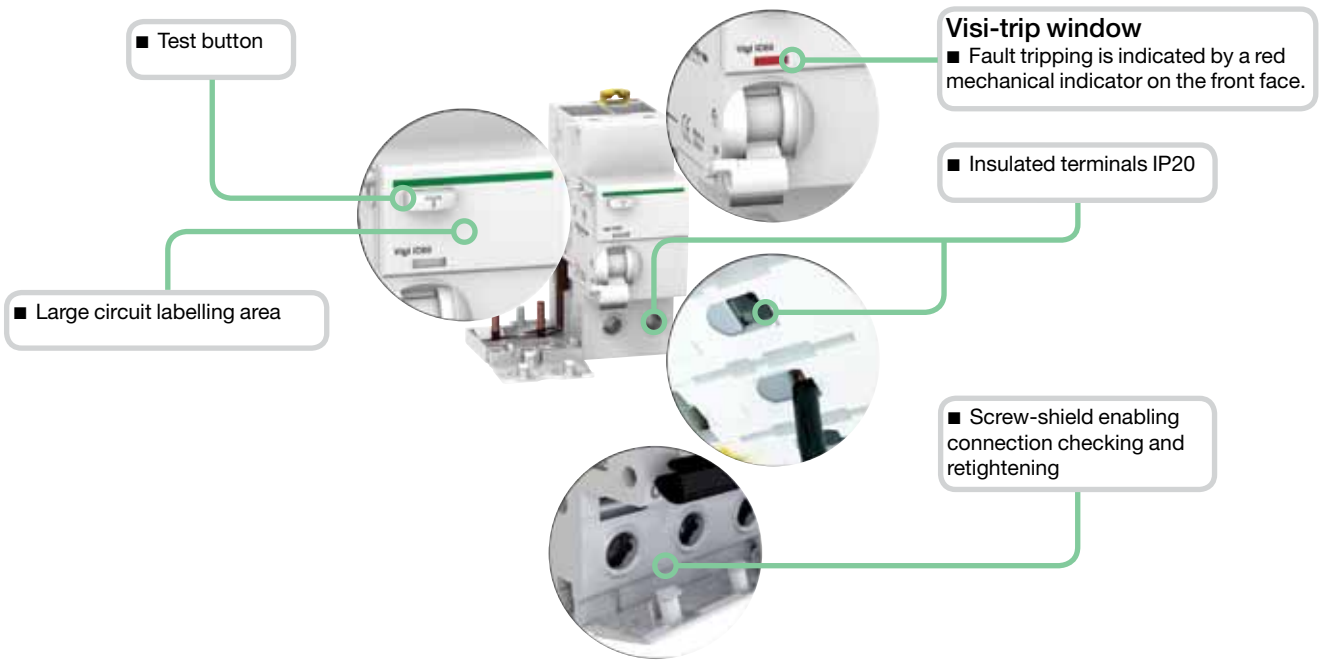

PB104466-40

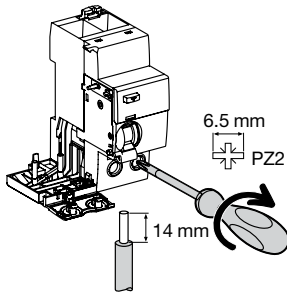

Connection

DB122948



Type	Rating	Tightening torque	Copper cables	
			Rigid	Flexible or ferrule
Vigi iC60	25 A	2 N.m		
	40 to 63 A	3.5 N.m		

DB123310

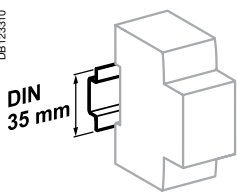

Clip on DIN rail 35 mm.

DB123312

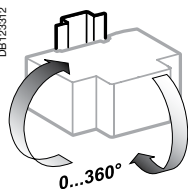

Indifferent position of installation.

DB123314

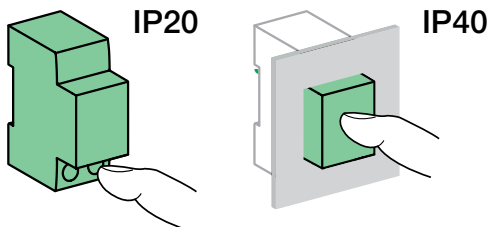



Technical data

Main characteristics

Insulation voltage (Ui)	500 V
Pollution degree	3
Rated impulse withstand voltage (Uimp)	6 kV

According to IEC/EN 61009-1

Surge current withstand (8/20 μs) without tripping	A type (no selective )	250 A
	A type (selective )	3 kA

Additional characteristics

Degree of protection	Device only	IP20
	Device in modular enclosure	IP40 Insulation classe II
Operating temperature	AC type	-5°C to +60°C
	A and <i>SI</i> types	-25°C to +60°C
Storage temperature		-40°C to +85°C

PB10472-40



PB10473-40



IEC/EN 61008-1

- The iID residual current circuit breakers provide:
 - protection of persons against electric shock by direct contact (≤ 30 mA),
 - protection of persons against electric shock by indirect contact (≥ 100 mA),
 - protection of installations against the risk of fire (300 mA or 500 mA).

Catalogue numbers

iID residual current circuit breakers									
Type	A							Width in 9 mm module	
Product	iID								
Auxiliaries									
2P	Sensitivity	10 mA	30 mA	100 mA	300 mA	500 mA	300 mA		
	Rating	16 A	A9R20216	-	-	-	-	4	
		25 A	A9R20225	A9R21225	-	A9R24225	-		
		40 A	-	A9R21240	-	A9R24240	-		A9R25240
		63 A	-	A9R21263	-	A9R24263	-		A9R25263
		100 A	-	A9R21291	-	A9R24291	-		A9R25291
4P	Sensitivity	10 mA	30 mA	100 mA	300 mA	500 mA	300 mA		
	Rating	25 A	-	A9R21425	-	A9R24425	-	8	
		40 A	-	A9R21440	A9R22440	A9R24440	A9R26440		A9R25440
		63 A	-	A9R21463	A9R22463	A9R24463	A9R26463		A9R25463
		80 A	-	A9R21480	-	A9R24480	-		A9R25480
		100 A	-	A9R21491	-	A9R24491	A9R26491		A9R25491
Voltage rating (Ue)	2P	230 - 240 V							
	4P	400 - 415 V							
Operating frequency	50/60 Hz								

iID residual current circuit breakers for 110/230 V			
Type	A		Width in 9 mm module
Product	iID		
Auxiliaries			
2P	Sensitivity	30 mA	
	Rating	63 A	A9R08263
4P	Sensitivity	30 mA	
	Rating	63 A	A9R08463
Voltage rating (Ue)	2P	110 V	
	4P	230 V	
Operating frequency	50/60 Hz		







IEC/EN 61008-1

- The iID residual current circuit breakers provide:
 - protection of persons against electric shock by direct contact (≤ 30 mA),
 - protection of persons against electric shock by indirect contact (≥ 300 mA),
 - protection of installations against the risk of fire (300 mA or 500 mA).

The *SI* type provides increased immunity from electrical interference and polluted or corrosive environments.

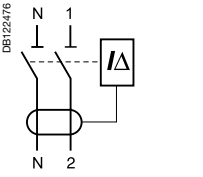
Catalogue numbers

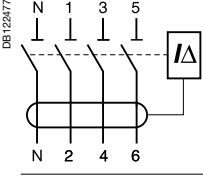
iID residual current circuit breakers							
Type	SI 						Width in 9 mm module
Product	iID						
Auxiliaries							
2P	Sensitivity	10 mA	30 mA	300 mA	300 mA 	500 mA 	
	Rating	16 A	-	-	-	-	4
	25 A	A9R30225	A9R61225	-	-	-	
	40 A	-	A9R61240	-	A9R35240	-	
	63 A	-	A9R61263	-	A9R35263	-	
	100 A	-	-	-	A9R35291	-	
4P	Sensitivity	10 mA	30 mA	300 mA	300 mA 	500 mA 	
	Rating	25 A	-	A9R61425	-	-	8
	40 A	-	A9R61440	-	A9R35440	A9R37440	
	63 A	-	A9R61463	A9R34463	A9R35463	A9R37463	
	80 A	-	A9R31480	-	A9R35480	A9R37480	
	100 A	-	A9R31491	A9R34491	A9R35491	-	
Voltage rating (Ue)	2P	230 - 240 V					
	4P	400 - 415 V					
Operating frequency	50/60 Hz						

Protection Earth leakage protection

iID residual current circuit breakers (AC, A, SI types)

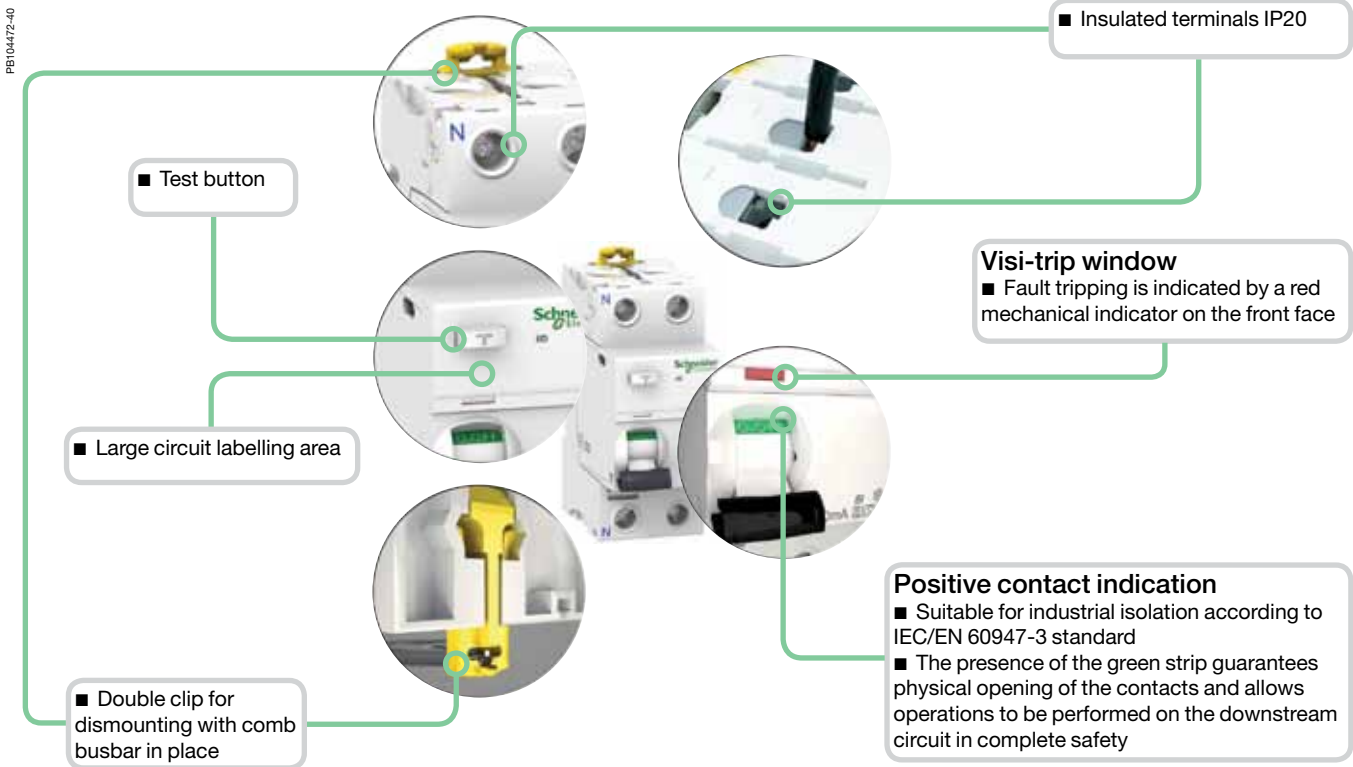

SI type

The *SI* type provides increased immunity from electrical interference and polluted or corrosive environments.

Protection Earth leakage protection

iID residual current circuit breakers (AC, A, S/I types) (cont.)

2

Connection

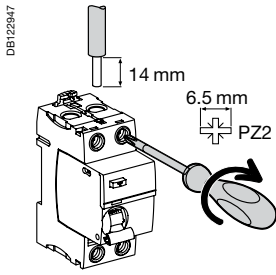

Type	Tightening torque	Without accessory		With accessories*			
		Copper cables Rigid	Copper cables Flexible or ferrule	50 mm ² Al terminal	Screw-on connection for ring terminal	Multi-cables terminal	
						Rigid cables	Flexible cables
iID	3.5 N.m	1 to 35 mm ²	1 to 25 mm ²	50 mm ²	Ø 5 mm	3 x 16 mm ²	3 x 10 mm ²

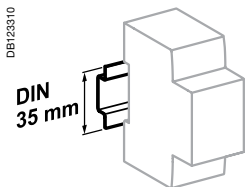

Clip on DIN rail 35 mm.

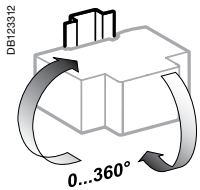

Indifferent position of installation.

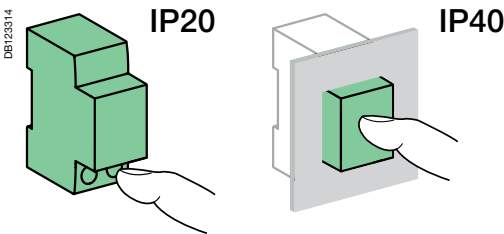

Technical data

Main characteristics			
Insulation voltage (U _i)	500 V		
Pollution degree	3		
Rated impulse withstand voltage (U _{imp})	6 kV		
According to IEC/EN 61008-1			
Making and breaking capacity (I _m /I _{Δm})	1500 A		
Surge current withstand (8/20 μs) without tripping	AC and A types (no selective Ⓢ)	250 Å	
	AC, A types (selective Ⓢ)	3 kÅ	
	S/I type	3 kÅ	
Conditional rated short circuit current (I _{nc} /I _{Δc})	With C60H	15 kA	
	With fuse	10,000 A	
Additional characteristics			
Degree of protection	Device only	IP20	
	Device in modular enclosure	IP40 Insulation classe II	
Endurance (O-C)	Electrical (AC1)	16 to 63 A	15,000 cycles
		80 to 100 A	10,000 cycles
	Mechanical		20,000 cycles
Operating temperature	AC type	-5°C to +60°C	
	A and S/I types	-25°C to +60°C	
Storage temperature	-40°C to +85°C		

Protection

Circuit protection

Earth leakage protection

Electrical auxiliaries for iC60, iID, iDPN Vigi, RCA and ARA

■ The electrical auxiliaries are combined with iC60 circuit breakers, iID residual current circuit breakers, remote tripping switch disconnectors iSW-NA, RCA remote controls and ARA automatic reclosers; they enable tripping or remote indication of their position (open/closed/tripped) upon a fault.

■ They are fastened by clips (without tools) to the left side of the breaker.

■ The iOF/SD+OF auxiliary is a 2-in-1 product: via a mechanical selector switch, it provides two contacts, OF+SD or OF+OF.

■ The iOF+SD24 auxiliary can report open/closed (OF) status information and intentional or fault tripping of the associated device (SD) to the Acti 9 Smartlink or a programmable logic controller via the Ti24 interface (24 V DC).

Tripping auxiliaries:

IEC/EN 60947-1

- iMN: undervoltage release
- iMNs: delayed undervoltage release
- iMNx: undervoltage release, independant from supply voltage
- iMX: shunt release
- iMX+OF: shunt release with open/close contact.

EN 50550

- iMSU: overvoltage release

Indication auxiliaries:

IEC/EN 60947-5-1

- iOF: open/close contact
- iSD: fault indicating contact
- iOF/SD+OF: open/close contact and switchable OF or SD contact.

IEC/EN 60947-5-4

- iOF+SD24: open/close contact OF and default indicating contact SD with Ti24 interface.

2

DB404939



2

The mounting order for the various auxiliaries must be complied with. The tripping auxiliaries (iMN, iMX) should be mounted first, as close as possible to the circuit breaker or the residual current circuit breaker. Then, the indicating auxiliaries (iOF, iSD) should be mounted, complying with their position shown in the following table.

Indicating auxiliaries

PB104474-25



PB104475-25













DB123583







1 (iOF/SD+OF or iOF+SD24 or iSD)	1 iOF/SD+OF
1 iOF	1 (iSD or iOF or iOF/SD+OF)
None	1 iOF+SD24
None	None
1 iSD	1 iSD
None	1 (iSD or iOF or iOF/SD+OF or iOF+SD24)
1 iOF	1 (iSD or iOF or iOF/SD+OF)
None	1 (iSD or iOF or iOF/SD+OF or iOF+SD24)
1 iOF	1 (iSD or iOF or iOF/SD+OF)



Tripping devices must be mounted first. Comply with the position of the SD function.
*iSW-NA : the iSD auxiliary contact must be associated with an auxiliary (iMN, iMX, iMX+OF); it indicates that the remote tripping switch disconnecter has been tripped open.

Tripping auxiliaries	Remote control	Device	Vigi iC60
 <p>PB104496-25</p>	ARA automatic recloser or RCA remote control	iC60 circuit breaker or iID residual current circuit breaker	Vigi iC60 add-on residual current device
1 (iMN, iMNs, iMNx or iMX, iMX+OF or iMSU) max.	-	 <p>PB104437-25</p> <p><i>iC60</i></p>	 <p>PB104466-25</p> <p><i>Vigi iC60</i></p>
2 (iMN, iMNs, iMNx or iMX, iMX+OF or iMSU) max.	-	-	-
2 (iMN, iMNs, iMNx or iMX, iMX+OF or iMSU) max.	-	-	-
3 iMSU max.	-	-	-
1 (iMN, iMNs, iMNx or iMX, iMX+OF or iMSU) max.	-	 <p>PB104472-25</p> <p><i>iID/iSW-NA</i></p>	-
1 (iMN, iMNs, iMNx or iMX, iMX+OF or iMSU) max.	 <p>PB108256-25</p> <p><i>ARA</i></p>	 <p>PB104437-25</p> <p><i>iC60</i></p>	 <p>PB104466-25</p> <p><i>Vigi iC60</i></p>
None	-	 <p>PB104472-25</p> <p><i>iID</i></p>	-
1 (iMX or iMN or iMSU) max.	 <p>PB106253-25</p> <p><i>RCA</i></p>	 <p>PB104437-25</p> <p><i>iC60</i></p>	 <p>PB104437-25</p> <p><i>Vigi iC60</i></p>
None	-	-	-

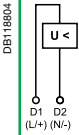
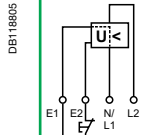

Tripping

Auxiliaries	iMN		iMNs		iMNx			
Type	Undervoltage release							
	Instantaneous		Delayed		Independent of the supply voltage			
								
Function	<ul style="list-style-type: none"> Trips the device with which it is combined when its input voltage decreases (between 70 % and 35 % U_n). Prevents device closing again until its input voltage is restored 			<ul style="list-style-type: none"> Not tripping on transient voltage dip (up to 0.2 s) 		<ul style="list-style-type: none"> Tripping of the associated device by opening of the control circuit (e.g. push-button, dry contact) A drop in the supply voltage does not trip the associated device A locking push-button control allows the circuit protected (e.g. machine control) to be placed in safety configuration 		
Wiring diagrams								
Use	<ul style="list-style-type: none"> Emergency stoppage by normally closed push button Ensures the safety of power supply circuits for several machines by preventing "uncontrolled" restarting 			<ul style="list-style-type: none"> Emergency stoppage with fail-safe principle Insensitive to control circuit voltage variation to increase service continuity Important: Before any servicing operation switch off the mains power supply (voltage presence at terminals E1/E2) 				
Catalogue numbers	A9A26960	A9A26961	A9A26959	A9A26963	A9A27108	A9A26969	A9A26971	
iC60, iID, iDPN Vigi, RCA and ARA	■	■	■	■	■	■	■	
Technical specifications								
Rated voltage (Ue)	V AC	220...240	48	115	220...240	24	220...240	380...415
	V DC	–	48	–	–	24	–	–
Standardised operating and non-response to voltage times (Ua)*		–	–	–	–	–	–	–
Maximum operating time		–	–	–	–	–	–	–
Minimum non-response time		–	–	–	–	–	–	–
Operating frequency	Hz	50/60	–	400	50/60	–	50/60	–
Red mechanical indicator		On front face			On front face		On front face	
Test function		–			–		–	
Width in 9 mm modules		2			2		2	
Operating current		–			–		–	
Number of contacts		–			–		–	
Operating temperature	°C	-35...+70			-35...+70		-35...+70	
Storage temperature	°C	-40...+85			-40...+85		-40...+85	

*(Ua)
Voltages measured between the phase and the neutral conductor, at which the iMSU device must control the associated protective device.

Protection
Circuit protection
Earth leakage protection



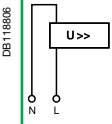
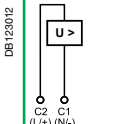
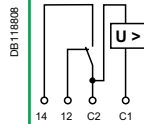

Electrical auxiliaries for
iC60, iID, iDPN Vigi, RCA and ARA
(cont.)

iMSU					iMX			iMX+OF				
Overvoltage release					Shunt release			With Open/Close auxiliary contact				
												
<ul style="list-style-type: none"> Switches off the power supply by opening the breaker with which it is combined, in the event that the phase/neutral voltage is exceeded (loss of neutral). For a four-phase network, use three iMSU tripping auxiliaries 					<ul style="list-style-type: none"> Trips the breaker when powered 			<ul style="list-style-type: none"> Includes an open/close contact (OF) to indicate the "open" or "closed" position of the breaker 				
												
<ul style="list-style-type: none"> Protection of equipment against overvoltages on the electrical network (neutral conductor break) Voltage monitoring between phase and neutral conductors 					<ul style="list-style-type: none"> Emergency stoppage by normally open push button 			<ul style="list-style-type: none"> Emergency stoppage by normally open push button Remote indication of the position of the associated breaker 				
A9A26500					A9A26476			A9A26477	A9A26478	A9A26946	A9A26947	A9A26948
■					■			■	■	■	■	■
230					100...415			48	12...24	100...415	48	12...24
-					110...130			48	12...24	110...130	48	12...24
255 V AC					275 V AC			300 V AC	350 V AC	400 V AC		
No tripping					15 s			5 s	0.75 s	0.20 s		
					3 s			1 s	0.25 s	0.07 s		
50/60					50/60					50/60		
On front face					On front face					On front face		
-					-					-		
2					2					2		
-					-					≤ 24 V DC 10 mA mini, 6 A maxi 48 V DC 2 A ≤ 130 V DC 1 A ≤ 240 V AC 6 A 415 V AC 3 A		
-					-					1 NO/NC		
-35...+70					-35...+70					-35...+70		
-40...+85					-40...+85					-40...+85		

Protection
Circuit protection
Earth leakage protection

Electrical auxiliaries for
iC60, iID, iDPN Vigi, RCA and ARA
(cont.)

2

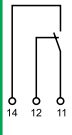
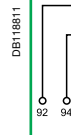
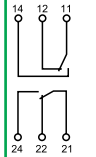
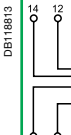
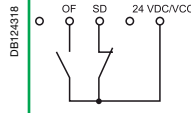
		Indication			
Auxiliaries		iOF	iSD	iOF/SD+OF	iOF+SD24
Type		Open/close auxiliary contact	Fault indicating contact	Double open/close or fault indicating contact	Double open/close and fault indicating contact
					
Function		<ul style="list-style-type: none"> Changeover contact indicates "open" or "closed" position of the breaker 	<ul style="list-style-type: none"> Changeover contact indicates position of the breaker; upon: <ul style="list-style-type: none"> electrical fault action on tripping auxiliary Same indication as VISI-TRIP 	<ul style="list-style-type: none"> The iOF/SD+OF auxiliary is a 2-in-1 product: via a mechanical selector switch, it provides two contacts, OF+SD or OF+OF 	<ul style="list-style-type: none"> 2 contacts (1 NO + 1 NC) can report the signalling information of the associated device to the Acti 9 Smartlink or a programmable logic controller: <ul style="list-style-type: none"> electrical fault actuation of the tripping auxiliary "Open" or "Closed" position of the associated device
Wiring diagrams				 	
Use		<ul style="list-style-type: none"> Remote indication of the position of the associated breaker 	<ul style="list-style-type: none"> Remote indication of tripping upon a fault of the associated breaker 	<ul style="list-style-type: none"> Remote indication of position and/or tripping upon a fault of the associated breaker 	<ul style="list-style-type: none"> Remote indication of position and tripping upon a fault of the associated breaker
Catalogue numbers		A9A26924	A9A26927	A9A26929	A9A26897
iC60, iID, iDPN Vigi, RCA and ARA		■	■	■	■
Technical specifications					
Rated voltage (Ue)	V AC	240...415	240...415	240...415	-
	V DC	24...130	24...130	24...130	24
Operating frequency	Hz	50/60	50/60	50/60	-
Red mechanical indicator		-	On front face	On front face	On front face
Test function		On toggle	On toggle	On toggle	On toggle
Width in 9 mm modules		1	1	1	1
Operating current	24 V DC	10 mA mini, 6 A maxi			2 mA mini, 50 mA maxi
	48 V DC	2 A			-
	60 V DC	1.5 A			-
	130 V DC	1 A			-
	240 V AC	6 A			-
	415 V AC	3 A			-
Number of contacts		1 NO/NC	1 NO/NC	1 NO/NC + 1 NO/NC	1 NO/NC
Operating temperature	°C	-35...+70	-35...+70	-35...+70	-25...+70
Storage temperature	°C	-40...+85	-40...+85	-40...+85	-40...+85

Connection

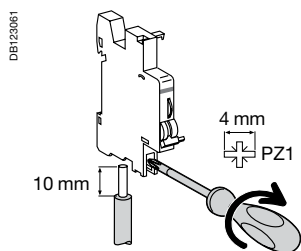

Type	Tightening torque	Copper cables		Multi-cables terminal	
		Rigid	Flexible	Rigid cables	Cables with ferrule
		DB123045	DB123007	DB123011	DB123008
Indication auxiliaries	1 N.m	1 to 4 mm ²	0.5 to 2.5 mm ²	2 x 2.5 mm ²	2 x 1.5 mm ²
Tripping auxiliaries	1 N.m	1 to 6 mm ²	0.5 to 4 mm ²	2 x 2.5 mm ²	2 x 2.5 mm ²



Ti24 connector connection

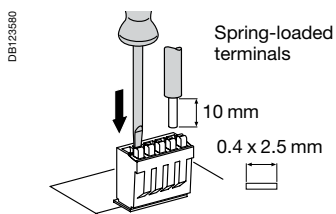

Type	Catalogue numbers	Copper cables	
		Rigid	Flexible
		DB123045	DB123553
Ti24 interface	A9XC2412	1 x 0.5 to 1.5 mm ²	1 x 0.5 to 1.5 mm ²

Ti24 prefabricated cables connection

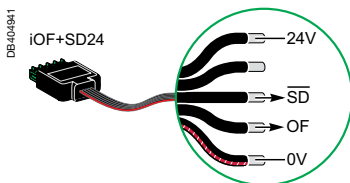

Type	Catalogue numbers	Length
Connection for Acti 9 Smartlink		
6 short prefabricated	A9XCAS06	100 mm
6 medium-sized prefabricated	A9XCAM06	160 mm
6 long prefabricated	A9XCAL06	870 mm
Connection for PLC type terminals		
6 long prefabricated on a single side	A9XCAU06	870 mm



Protection

Circuit protection

Earth leakage protection

Accessories for iC60, iID, iDPN Vigi, Reflex iC60, RCA, ARA and iSW

2

		Mounting						
Accessories		Rotary handle			Plug-in base			
								
Function		<p>Front or side-mounted control</p> <ul style="list-style-type: none"> ■ Degree of protection: IP55 rotary handle ■ Installation: <ul style="list-style-type: none"> <input type="checkbox"/> the control mechanism is mounted on the device <input type="checkbox"/> the rotary handle is fixed to the front or side of the enclosure ■ Front-mounted (on door or faceplate) <ul style="list-style-type: none"> ■ Prevents the door from opening when the device is in the ON position (can be deactivated) ■ Can be padlocked when the device is in the "open" position (can be padlocked with the device in the "closed" position subject to adaptation) ■ Can be locked by padlock of (dia. 5 to 8 mm), not supplied with the device ■ Pushbutton: iID test available in the front face of the rotary handle 			<ul style="list-style-type: none"> ■ The Laser Square tool brings the accuracy to align the circuit breaker and the rotary handle 		<p>Allows a breaker to be removed or replaced quickly, without handling the connections</p> <ul style="list-style-type: none"> ■ Degree of protection: IP20 ■ Consists of: <ul style="list-style-type: none"> <input type="checkbox"/> a base to be fastened on a rail (or panel) <input type="checkbox"/> 2 "blades" to be fastened in the device's terminals ■ Connection: tunnel terminals for cable up to 35 mm² rigid, 25 mm² flexible, ■ Installation: <ul style="list-style-type: none"> <input type="checkbox"/> in universal enclosure <input type="checkbox"/> on horizontal rail ■ Height: 178 mm ■ Not compatible with Vigi iC60 and auxiliaries ■ Can be locked by padlock of (dia. 6 mm), not supplied with the device 	
Catalogue numbers		A9A27005	A9A27006	A9A27008	GVAPL01	A9A27003 (1 per pole)		
		Operating sub-assembly						
		+	+					
		Black handle	Red handle	No handle				
Set of		1	1	1	1	1		
Suitability								
iC60	■ 2P, 3P, 4P			■				
iSW	■ 2P, 3P, 4P			■				
iC60 + Vigi iC60	■ 2P, 3P, 4P			-				
iID	■			■ ≤ 63 A				
Reflex iC60 or RCA+iC60 or ARA+iC60	-			-				
ARA+iID	-			-				

Protection
Circuit protection
Earth leakage protection

Accessories for iC60, iID, iDPN Vigi,
Reflex iC60, RCA, ARA and iSW (cont.)

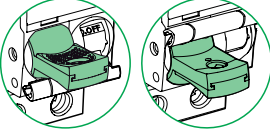
Padlocking device			
PE104492-15			
DB12399B			
<p>Used to padlock breaker in open or closed position</p> <ul style="list-style-type: none"> ■ Padlock diameter: 3 to 6 mm ■ Sealable (max. diameter: 1.2 mm) ■ Locking in ON position does not prevent tripping of the breaker in the event of faults ■ Suitable for IEC/EN 60947-2 compliant disconnection 			
	MCB/RCCB	MCB in ISOBAR	RCBO in ISOBAR
	A9A26970	SEA9LA	A9A27049
	10	3	10
	<ul style="list-style-type: none"> ■ ■ ■ ■ ■ 		







Protection

Circuit protection

Earth leakage protection

Accessories for iC60, iID, iDPN Vigi, Reflex iC60, RCA, ARA, iSW (cont.)

2





Security						
Accessories	Screw shield		Terminal shield		Inter-pole barrier	Spacer
						
Function	Prevents any contact with the connecting screws <ul style="list-style-type: none"> Upgrades degree of protection to IP20D Sealable, max. diameter 1.2 mm 		Prevents any contact with the terminals <ul style="list-style-type: none"> Upgrades degree of protection to IP20D Sealable, max. diameter 1.2 mm Set of two, for upstream and downstream terminals For 3 poles: A9A26975 + A9A26976 For 4 poles: 2 X A9A26976 		Enhances insulation between connections: cables, terminals, lugs, etc	<ul style="list-style-type: none"> Used to: <ul style="list-style-type: none"> complete rows separate devices. Width: 1 x 9 mm module Allows cable routing from one row to another, (above and below), up to 6 mm²
Catalogue numbers	A9A26982	A9A26981	A9A26975	A9A26976	A9A27001	A9A27062 DIN mounted A9A27063 Breaker mounted
Set of	12 x 1 pole	20 x 4 poles (splittable)	2 x 1 pole	2 x 2 poles	10	5
Suitability						
iC60	-	■	■	■	■	■
iSW	-	-	■	■	■	■
Vigi iC60	■	-	-	-	-	■
iID	-	■	-	■	■	■
Reflex iC60 or RCA+iC60 or ARA+iC60	-	■	■	■	■	■
ARA+iID	-	■	-	■	■	■

Protection

Circuit protection

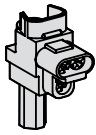
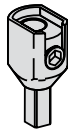
Earth leakage protection

Accessories for iC60, iID, iDPN Vigi, Reflex iC60, RCA, ARA, iSW (cont.)

		Connection		
Accessories	Multi-cable terminal	50 mm ² terminal Al	Screw-on connection for ring terminal	
				
Function				
	For 3 copper cables: ■ Rigid up to 16 mm ² ■ Flexible up to 10 mm ²	For aluminium cables from 16 to 50 mm ²	For lug tipped cables, front or rear mounting	
			 Ø 5 mm	
Catalogue numbers	19091	19096	27060	27053
Set of	4	3	1	8
iC60 ≤ 25 A	-	-	-	■
Reflex iC60 ≤ 25 A	-	-	-	■
iC60 > 25 A	■	■	■	■
Reflex iC60 40 A, iSW	-	-	-	-
Vigi iC60	-	-	-	-
iID	■	■	■	■
iDPN Vigi	-	-	-	■
iSW-NA	■	■	■	■
Tightening torque	2 N.m		10 N.m	2 N.m
Length stripping	11 mm		13 mm	-
Tools to use	Dia. 5 mm or PZ2		Hc 1/5" or 5 mm	Dia. 5mm

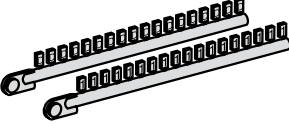
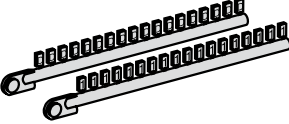
		Marking				
Accessories	Marker strip					
						
Used for connection identification						
Catalogue numbers	0: AB1-R0 1: AB1-R1 2: AB1-R2 3: AB1-R3 4: AB1-R4	5: AB1-R5 6: AB1-R6 7: AB1-R7 8: AB1-R8 9: AB1-R9	A: AB1-GA B: AB1-GB C: AB1-GC D: AB1-GD E: AB1-GE F: AB1-GF G: AB1-GG H: AB1-GH I: AB1-GI	J: AB1-GJ K: AB1-GK L: AB1-GL M: AB1-GM N: AB1-GN O: AB1-GO P: AB1-GP Q: AB1-GQ R: AB1-GR	S: AB1-GS T: AB1-GT U: AB1-GU V: AB1-GV W: AB1-GW X: AB1-GX Y: AB1-GY Z: AB1-GZ	+ : AB1-R12 - : AB1-R13 blank: AB1-RV
Set of	250					
iC60, Reflex iC60, iSW	■ 4 markers max. per pole					
Vigi iC60	■ 4 markers max. per device					
iID	■ 4 markers max. per device					
iDPN Vigi	■ 4 markers max. per device					
iSW-NA	■ 4 markers max. per device					

Protection

Circuit protection

Earth leakage protection

Accessories for iC60, iID, iDPN Vigi, Reflex iC60, RCA, ARA, iSW (cont.)

Dimensions (mm)

2

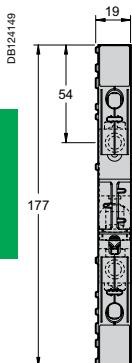

Plug-in base

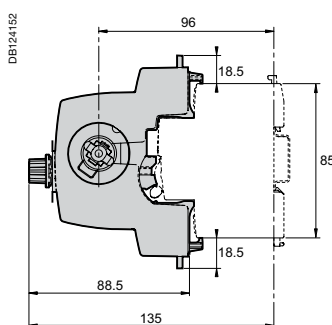
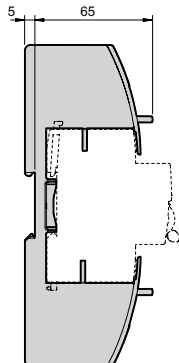

Adapter mechanism

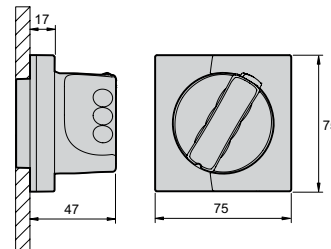

Handle

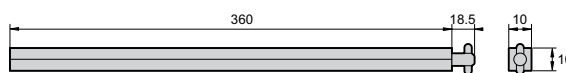

Rotary handle

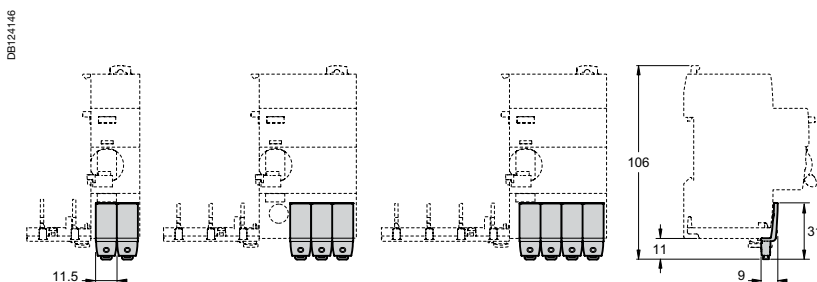

Screw shield 1P (A9A26982)

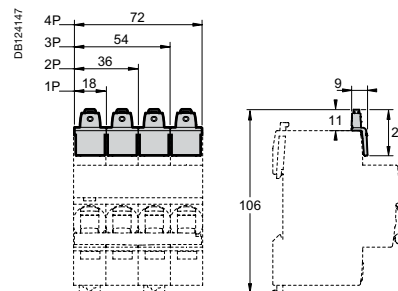

Screw shield 4P (A9A26981)

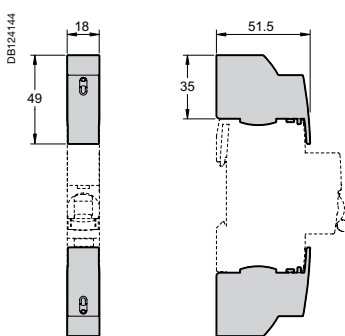

Terminal shield 1P

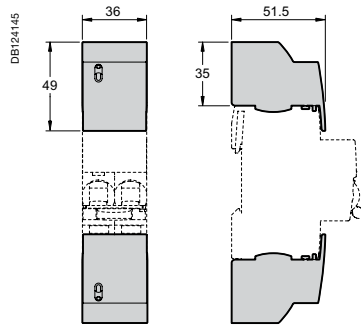

Terminal shield 2P

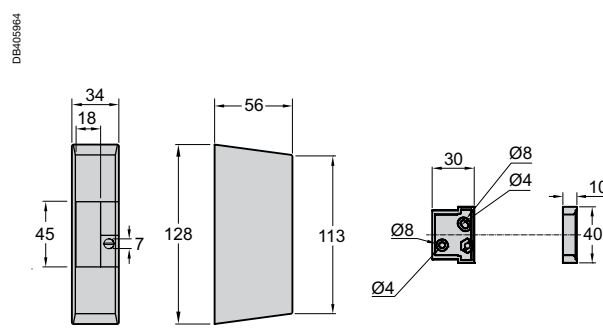

Wall mounted

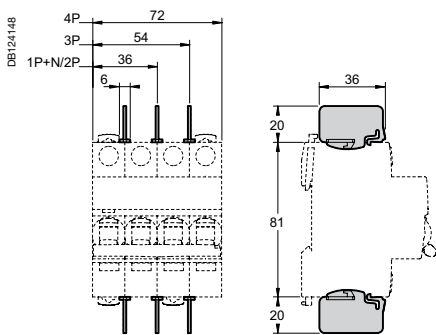

Inter-pole barrier

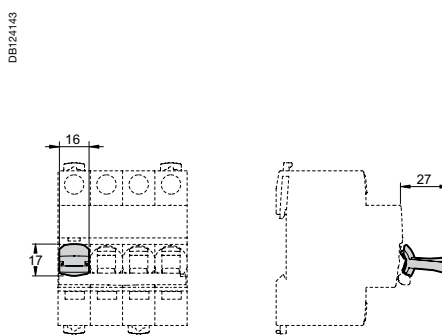

Padlocking device

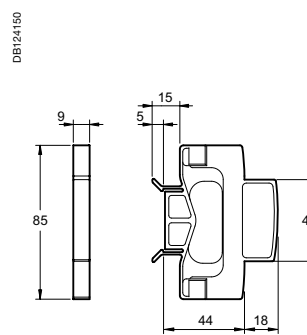

Spacer

Rotary handle installation

Dimensions (mm)

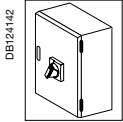

iC60	Z (mm)
2P	25.3
2P + Vigi	25.3
3P	25.3
3P + Vigi	43
4P	43
4P + Vigi	43

iID	Z (mm)
2P	25.3
4P	25.3

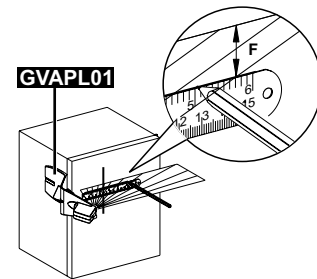
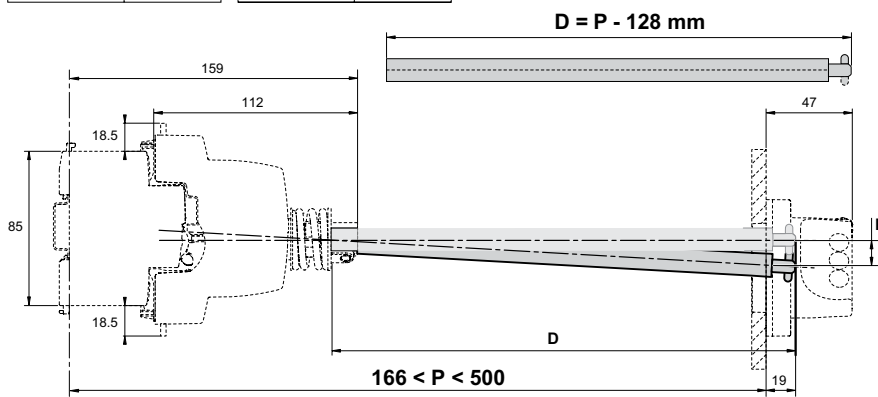
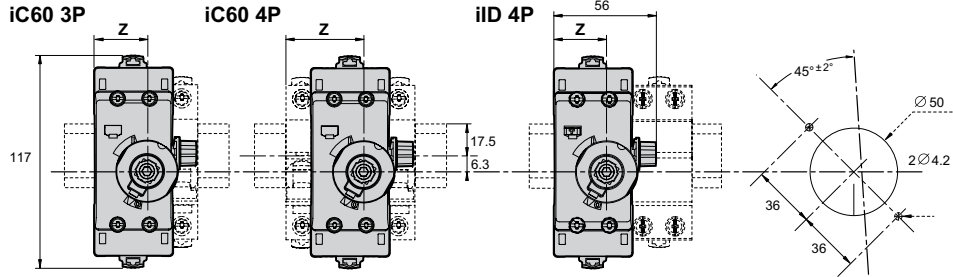

P (mm)	F (mm)
300	5
500	11

Rotary handle: front mounted control

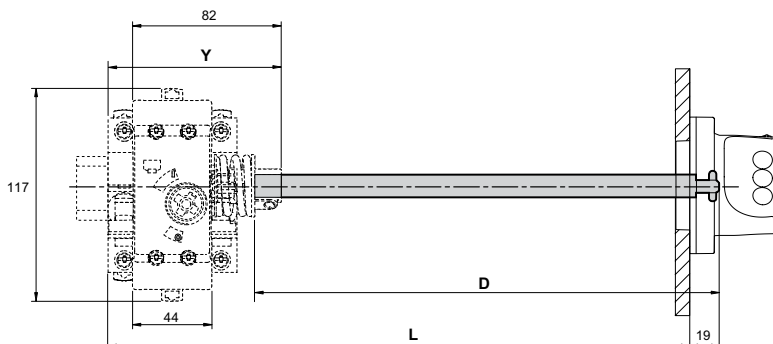
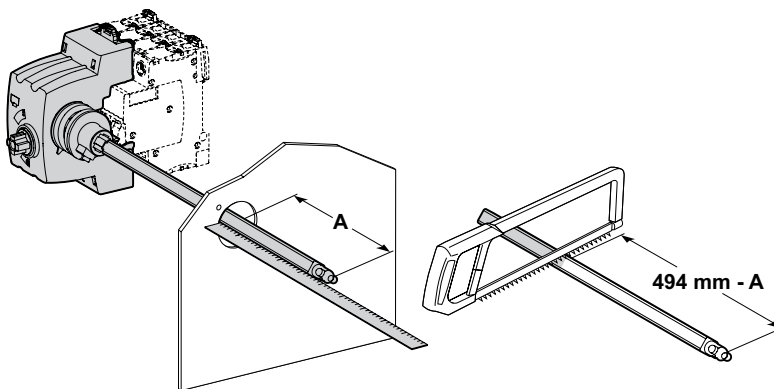
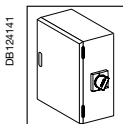

iC60	X (mm)	Y (mm)
2P	44.5	76.8
2P + Vigi	44.5	76.8
3P	44.5	76.8
3P + Vigi	62	94.5
4P	62	94.5
4P + Vigi	62	94.5

iID/iSW-NA	X (mm)	Y (mm)
2P	44.5	76.8
4P	44.5	76.8



Rotary handle: side mounted control